

JOBCOM® JMX D-SERIES OWNERS MANUAL

Includes table
frequency list of
77 UHF & 26 VHF
codes for easy field
programming

DISPLAY-SERIES HANDHELDS COMPACT, ULTRA-SMALL PROFESSIONAL TWO-WAY RADIOS

- 1 to 10 Channel Capability
- Easier, Enhanced Field Programming
- 1, 2, 3, or 4 Watt Models
- Channel Scan
- Easy-to-hear, High Audio Output
- Built-in Quiet Call® Interference Eliminator
- NOAA Weather Channel Feature (VHF only)
- Emergency Weather Alert Feature (VHF only)
- Extra Features for JMX-144D / 444D / 446D
- 2013 FCC Narrowband Compliant



JOBCOM
JMX BY RITRON

ACCESSORIES



RHD-1X
Single Ear Headset



RHD-6X
Behind-the-head Earset



RHD-8X
Single Earbud



RHD-4X
Dual Ear Headset



RSM-3X
Remote Speaker Mic

OPTIONAL ACCESSORIES:

TO ORDER CALL 800-USA-1-USA

BPS-6N-MHReplacement High Capacity Battery

AFS-150.....VHF Molded Flex Antenna

AFS-450.....UHF Molded Flex Antenna

RHD-1XSingle Ear Headset

RHD-4XDual Ear Headset

RHD-6XLightweight Behind-the-head Earset w/ In-line PTT

RHD-8XLightweight Earbud w/ mic and In-line PTT

RSM-3XRemote Speaker Microphone

REP-2Low Profile Earphone

CCL-BCigarette Lighter Charger

MHC-ACordura Holster w/ belt clip & neck strap

BCJS-4AD4-Well Drop-in Charger: JMX

BCPS-4AD4-Well Drop-in Charger: SST

BCJS-ADSingle-Well Drop-in Charger (Overnight)

BCC-PSDrop-in High-rate Charger/Conditioner

Call RITRON for complete listings.



BCJS-AD
Single-Well Drop-in Charger



BPS-6N-MH
Spare Battery



BCJS-4AD
4-Well Drop-in Charger



MHC-A
Cordura Holster

TABLE OF CONTENTS

DESCRIPTION..... PAGE

ACCESSORIES

Optional Accessoriesii

INTRODUCTION

JMX "D-Series" Model Numbers 1

Features 1

Inspection 2

2013 FCC Narrowband Mandate 2

CONTROL & OPERATION 3

FIG-1: Radio Controls and Connectors 3

OPERATION

On-off / Volume Adjust 4

Channel Selection 4

Receive 4

Quiet Call Tone Codes 5

Transmit 5

Radio Alert Tones 5

Optional Alert Tones 6

FIG-2: Transmit / Busy Lamp 6

Scan Channel Operation 7

Additional Features 8

NOAA WEATHER RADIO

Selecting Your Local NOAA Weather Frequency 9

NOAA Weather Channel 9

Weather Alert 9

FIG-4: To Select Your Local NOAA Weather Frequency 9

FIG-5: NOAA Frequencies 9

RADIO PROGRAMMING

FIG-6: How to Place the Radio in Program / Readout Mode 10

How to Readout Field Programmed Frequency & Tone Codes 10

How to Field Program Frequency & Tone Codes 11

DESCRIPTION..... PAGE

TABLE 1: Programmable Frequency Codes 12

TABLE 2: Programmable QC Tone Codes 13

TABLE 3: Programmable DQC Codes 13

How to Delete a Channel 13

How to Field Program Radio Options 13

TABLE 4: Radio Option Codes 13

BATTERIES

FIG-7: Battery Access and Installation 14

Optional Charging Accessories 14

Charging 15

Battery Maintenance and Conditioning 15

!! CAUTIONS – ALL RADIOS !!

Observe Caution in the Following Environments to Maximize the

Life of Your Radio Equipment 16

Exposure to Radio Frequency Energy 16

SPECIAL APPLICATIONS

How to Field Program 2-Tone Encode Codes 17

(for GateGuard Applications, go to www.ritron.com/pdf/gg_07.pdf)

TABLE 5: Programmable 2-Tone Encode Codes 17

TROUBLESHOOTING

Notes 18

Chart 18

FCC LICENSE REQUIREMENT

FCC Regulations 19

Service 19

How to Obtain an FCC Radio License 19

LIMITED WARRANTY BACK COVER

NOTE: Refer to pages ii and 14 for Accessory information.

INTRODUCTION

THANK YOU FOR CHOOSING RITRON

Congratulations on your purchase of the JMX “D-Series” radio. Your new radio is the result of Ritron’s 25+ years of designing, manufacturing, and supplying reliable, professional wireless communication products. Ritron wireless products will improve the operation, safety, and profitability of any organization by providing instant voice communications between employees throughout the workplace.

JMX “D-SERIES” MODEL NUMBERS

VHF MODELS

JMX-111D (Jobcom) (1-Watt, 1 Channel)

JMX-141D (Jobcom) (1.5-Watt, 10 Channel)

JMX-146D (Jobcom) (2-Watt, 10 Channel)

JMX-144D (Jobcom) (4-Watt, 10 Channel)

UHF MODELS

JMX-441D (Jobcom) (1-Watt, 10 Channel)

JMX-446D (Jobcom) (2-Watt, 10 Channel)

JMX-444D (Jobcom) (3-Watt, 10 Channel)

The model number located on the back of the radio case indicates its operating band. A color “dot” label on the bottom of JMX radio cases also indicates the frequency. Refer to the Frequency Table on page 12.

VHF band radios are designed to operate between 150 and 162 MHz.

UHF band radios are designed to operate between 450 and 470 MHz.

FEATURES

This manual covers the JMX “D-Series” radios.

Each radio (except JMX-111D) is capable of 10 channels. The radios are programmed from the factory with 2 channels. All models (except JMX-111D) can add a scan channel. All VHF models can be programmed to receive NOAA weather broadcasts. Each radio is equipped with the following features:

- **Push-button operating controls.** The Push-To-Talk (PTT) and Channel buttons are on one side of the radio, and the On / Volume Up, Volume Down/Off and monitor controls on the top.
- **Channel display.** The LED display will show the current operating channel, and contains a transmit / busy lamp.
- **Quick-change battery pack and drop-in charger capabilities.** See Optional Charging Accessories on page 14.
- **10-channel capability (except JMX-111D).** Up to 10 channels can be programmed to contain a unique channel table frequency and interference eliminator code.
- **QC (Quiet Call) interference eliminator codes.** Each channel can be programmed from a list of 50 QC sub-audible codes.
- **Field programming.** The JMX “D-Series” radio allows you to quickly select and program each channel individually while in the field without the need for a PC programmer. Each channel can be programmed to one of 26 VHF or 77 UHF channel table frequencies and one of 50 QC or 104 DQC (selected models, refer to page 10) interference eliminator codes, or you can delete a channel altogether.

INTRODUCTION

- **Channel scanning (except JMX-111D).** The Scan channel allows scanning of all channels programmed into the radio. The Scan channel can be turned On and Off through Field programming,
- **Low battery alert.** The radio will sound a low battery alert tone when your battery is running down to allow you time to recharge or change your battery.
- **Weather Channel.** VHF models can be programmed to receive your local NOAA weather radio broadcast. The Weather channel can be turned On and Off through Field programming.
- **Weather Alert.** VHF models can be programmed to alert you when the National Weather Service detects threatening weather conditions. The Weather Alert feature can be turned On and Off through Field programming.

INSPECTION

Make sure the package includes:

- JMX “D-Series” radio
- Antenna
- Rechargeable battery pack (installed in radio)
- Belt clip
- BC-A charger cube

Examine the equipment immediately after delivery and report any damage to your shipping company.

2013 FCC NARROWBAND MANDATE

On January 1, 2013, pursuant to the FCC Narrowband mandate, Ritron will no longer be allowed to manufacture wide band (25 kHz) capable radio equipment that operates in the frequency bands from 150 MHz to 512 MHz. All Ritron D-Series Radios are FCC certified for narrowband operation, so the only change required is the elimination of wideband operation.

To meet the FCC narrowband mandate by Jan 1, 2013, Ritron will initiate the transition process of manufacturing narrowband only compliant radio equipment beginning July 1, 2012. After that date, customer orders will begin to be filled with radios manufactured for FCC narrowband compliance, with no provisions for wideband operation except where allowed by FCC rule. These radios will be clearly marked as “FCC Narrowband Compliant”. The narrowband manufacturing process will proceed gradually on a model by model basis, with all models narrowband compliant by the January 1, 2013 deadline.

For a complete list of Ritron radios capable of narrowband operation; a Ritron FAQ on the subject, and various links on the FCC website dealing with Narrowbanding go to:

www.ritron.com/narrowband

If you have any questions contact us at 1-800-872-1872.

CONTROL & OPERATION

1 ANTENNA

The flexible antenna radiates and receives radio signals. Screw the antenna base all the way into the threaded bushing on top of the radio.

NOTE: Use only the type of antenna furnished with the radio. VHF and UHF antennas are not interchangeable.

2 ON / VOLUME UP

To switch the unit On, press the On / Volume Up button; the speaker will emit a turn on beep. If the radio turns on to the Scan Channel it will emit the Scan Beep. Once the radio is On, press this button to increase volume.

3 VOLUME DOWN / OFF

Press the Volume Down / Off button to decrease volume. To switch Off the unit, press and hold this button until the speaker emits a double beep.

4 PUSH-TO-TALK SWITCH (PTT)

Press and hold the PTT when transmitting; release it to receive.

5 CHANNEL SELECTOR

Press the button and the radio will emit the channel beep, advance the channel, and the channel display will show the new operating channel. When the Scan Channel is selected the radio will emit the Scan Beep and the radio will begin scanning.

6 BATTERY ACCESS DOOR (CASE BOTTOM)

The battery access door may be removed to access the battery pack. Refer to "FIG-7: Battery Access & Installation" on page 14.

7 JACK COVER

This rubber cover seals out dust and moisture, etc. Snap the cover into the audio accessory jack and charge jack openings when the jacks are not in use.

8 AUDIO ACCESSORY JACK

The audio accessory jack is used to plug in earphone options, and, in conjunction with the charge jack, to connect an optional remote speaker / microphone or a single- or dual ear headset. This jack is also used for PC programming.

9 CHARGE JACK

The battery pack may be charged through this jack using the RITRON charger cube. Refer to Accessories, page ii, for additional charging options.

10 CHANNEL DISPLAY

The channel display will indicate the current operating channel. When the Scan Channel is selected the display will rapidly flash the channels being scanned, and will stop when a channel is received.

11 SPEAKER

The speaker, located behind the front grille, allows you to hear calls on your channel.

12 MICROPHONE

The microphone allows your voice to be heard in transmissions to other radios. Speak in a normal tone; shouting does not improve your listener's reception.

13 DROP-IN CHARGING CAPABILITY

Two contacts, in the bottom of the battery pack, permit charging the battery pack with an optional drop-in charger. Refer to "Optional Charging Accessories" on page 14.

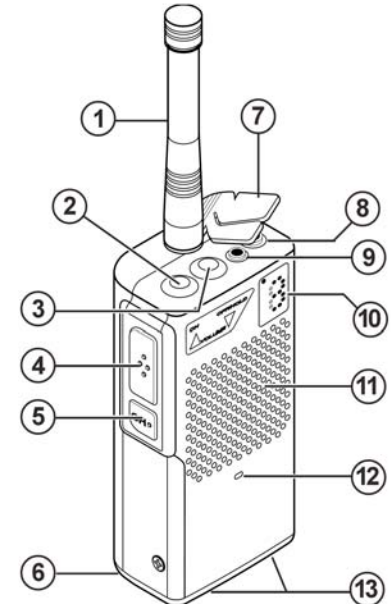

FIG-1: RADIO CONTROLS & CONNECTORS

IMPORTANT: CHARGE THE BATTERY PACK before using the radio for the first time. Refer to Batteries, pages 14 and 15.

OPERATION

ON-OFF / VOLUME ADJUST

To turn on the radio - press the On / Volume Up button. The radio will emit a beep and the channel display will light. If the radio turns on to the Scan Channel it will emit the Scan Beep. The radio will always turn on to the channel that was selected when it was last turned off.

To adjust the volume - press the volume up or volume down button until you reach the desired level. The volume level is displayed as a number between 0 through 9.

To turn OFF "beeps" - speaker beeps can be disabled through field programming to provide a silent mode of operation (ideal for security applications), only your incoming calls will be heard on the speaker. Refer to page 13 for How to Field Program Radio Options.

When speaker beeps are disabled only the low battery indication and 2-Tone decode ring tone, if enabled, are retained.

To turn off the radio - press and hold the Off / Volume Down button until a two tone "turn-off beep" is heard. For instant turn-off, press the PTT button while holding the Off / Volume Down button.

CHANNEL SELECTION

To change channels - press and release the Channel Selector button. The radio will emit a short Channel beep, increment the channel, and the Channel Display will show the new operating channel. If the highest channel number is selected and you press the Channel Selector button, the radio resets to channel 1 and the Channel beep is heard on the speaker.

If the Scan Channel is selected - the radio will emit the Scan Beep and the Channel Display will rapidly flash the channel numbers as they are scanned. If a signal is received the channel display will indicate the channel number, and when the received signal is removed the radio will wait briefly, sound the Scan Beep, then scanning will resume as normal.

If the Weather Channel is selected - on a VHF radio the Channel beep will be heard and the display will light a single segment that indicates which of the seven NOAA frequencies is monitored. See the "NOAA Weather Radio" section on page 9 for details.

RECEIVE

To hear calls from other users - adjust the volume as desired. The radio can only receive broadcasts while the Push-To-Talk button is not being pressed.

Whether or not you hear these broadcasts depends upon the squelch settings. There are two standard squelch modes that can be used in the JMX "D-Series" portable.

- Carrier Squelch lets you hear all broadcasts on your channel strong enough for the radio to detect, and silences noise.
- Tone Squelch uses the QC or DQC "tone squelch" format available on the JMX. This allows you to screen out "on-channel" broadcasts that do not carry the correct code programmed for the radio.

When Carrier or Tone Squelch is selected by the user, all channels will operate in that mode. The JMX "D-Series" radio will operate in tone squelch mode when it is first turned on.

OPERATION

To activate **Tone Squelch** or **Carrier Squelch** and to **Monitor the channel** - simultaneously press both the volume buttons and hold briefly before releasing.

- If the radio emits a **SINGLE** beep, then **Tone Squelch** is turned **ON** and you will only hear radio transmissions on that channel with the same QC or DQC tone codes as your radio.
- If the radio emits a **DOUBLE** beep, then you are in **Carrier Squelch** and you can **Monitor** all broadcasts on the channel. To exit **Carrier Squelch** press and hold both volume buttons until you hear the **SINGLE** beep.

Note: It is possible that the beginning of a call might be missed while the radio is in battery saver mode. If this happens, ask the caller to repeat the message.

If you are unable to activate **Carrier Squelch** - the radio has been optionally programmed for Monitor Lockout. See your Ritron dealer or contact Ritron directly to disable this option.

QC TONE CODES (Interference Eliminator Codes)

Tone codes help filter out the “chatter” of others that share your radio channel. When you operate on a frequency with a tone code, you screen out most interference. This allows you to hear only those users in your radio group.

IMPORTANT! All radios in the talk group must operate on the same frequency and tone code.

TRANSMIT

Normally, you should not transmit until the channel is quiet. This can be determined by monitoring the channel prior to transmitting.

To **transmit** - hold down the Push-To-Talk button and with the radio four inches away talk into the microphone. Speak in a normal tone, since talking louder will not improve the listener's reception.

Keep talk times as short and infrequent as possible to conserve battery, minimize radio frequency exposure, and allow others to use the channel.

RADIO ALERT TONES

The handheld responds to certain instructions by sounding a beep or series of tones. These tones can tell you that the radio is working as you expect.

Power On / Self Check “OK”

When it is first turned on, the radio runs a quick “self test” to confirm basic functions. When complete the radio will emit the channel beep and the Channel Display will show the operating channel. The radio is then ready to use.

Error Tones

However, if the “self test” detects a diagnostic error, an error tone sounds. The error tone indicates the radio frequency synthesizer is malfunctioning. Turn off the radio and try again. The error tone will also sound if a channel has been programmed for an invalid frequency. A long, low-pitched tone means the battery voltage is too low to operate the radio. In this case, recharge the battery. If you cannot correct a problem, consult an authorized Ritron service facility or Ritron.

OPERATION

Channel Select

When the Channel button is pressed, the radio will emit a short Channel beep, increment the channel, and the channel display will show the new operating channel.

Scan Channel (except JMX-111D)

When the Scan channel is selected by pressing the Channel button, the radio will emit the Scan beep and begin scanning.

Tone Squelch

When you press and hold both Volume buttons at the same time, a single beep will sound to indicate that tone squelch is on. A “double beep” means that carrier squelch is on.

Recharge Battery Alert

As the battery voltage approaches the minimum required “operating voltage” the radio will emit a series of short beeps to alert the user that the battery will soon need recharging. Once the battery charge drops below the required “operating voltage,” the radio emits a long, low tone and turns itself off. If you turn the radio back on, it will beep again and shut itself off. Recharge the battery.

Transmitter Time Out

A low tone followed by a higher-pitched tone sounds and the transmitter automatically shuts off if you hold down the PTT button longer than 60 seconds. The radio automatically switches to receive mode.

OPTIONAL ALERT TONES

JMX “D-Series” models JMX-144D / 444D / 446D can be programmed using the RITRON PC Programmer for optional alert tones. See your Ritron dealer or contact Ritron directly for programming of these options.

Receive Squelch Tone

A short tone sounds at the end of each received transmission to indicate that the channel is clear and you may transmit.

Busy Channel TX Inhibit

If a user is transmitting on your radio frequency without your tone, you will not be allowed to transmit. The radio will beep a series of long, low tones while the PH is held down (like a busy signal).

Transmit Clear To Talk Beep

A short tone sounds after the PTT has been pressed to indicate that the radio is ready for you to begin talking.

A Transmit / Busy Lamp in the upper left corner of the Channel Display is lit whenever the transmitter is activated and blinks when the channel is busy.



FIG-2: TRANSMIT / BUSY LAMP

OPERATION

SCAN CHANNEL OPERATION

Channel scanning allows you to listen to broadcasts on your radio channels. The JMX "D-Series" (except JMX-111D) will scan all channels programmed into the radio with the exception of the NOAA Weather Channel, refer to page 9.

How Scanning Works

Using the Channel Selector button, select the Scan Channel. The radio sounds the Scan Beep, and then repeatedly checks each channel in the scan list. The channel display will show the channel numbers as they are scanned.

When receiving a call on a channel being scanned, the radio will stop scanning to let you hear communications on that channel. After the transmission has ended the radio will pause before it resumes scanning to allow you time to respond.

When transmitting from the Scan Channel, the handheld will go to the last channel on which a signal was received, then transmit. After you release the PTT the radio will pause to allow time for a response, and then resume scanning.

Busy Channel Blocking

If one of the channels in the scan list is so busy that you want to temporarily block it out, press the Channel Selector button while the radio is stopped on the channel to be blocked and hold it until scanning resumes. The blocked channel will now be skipped in the scan list. The blocked channel will be returned to the scan list if the radio is turned off, or when the radio channel is changed using the Channel Selector button. Channel 1 cannot be blocked.

Last Channel Scanned Alert Tone

When changing channels with the Channel Selector button, an alert tone will sound to indicate the last channel that received a message when the radio was scanning. This will identify the channel on which the last message was received, and allow uninterrupted transmission on that channel without the constraints of scanning. You can then press the Channel Selector button to return to the Scan Channel.

Priority Scanning (Optional)

The JMX-144D / 444D / 446D radios can be optionally programmed for priority scanning. Priority Scan allows you to periodically monitor a Priority Channel, even if the radio has stopped on another channel. This will prevent missed calls on the primary operating channel when in scan mode.

With Priority Scan enabled:

- The first channel in the scan list is the Priority Channel.
- The radio checks the Priority Channel every two seconds to check for activity. This time is programmable and can be set for 1 - 8 seconds.
- The radio can be programmed to transmit only on the Priority Channel when scanning, if desired.
- The radio can be programmed to sound a Priority Channel Beep whenever the radio receives on the Priority Channel when scanning.

See your Ritron dealer or contact Ritron directly for PC programming of this option.

OPERATION

ADDITIONAL FEATURES

The JMX “D-Series” handheld radios have other features available through PC programming. See your Ritron dealer or contact Ritron directly for PC programming of these options.

- **Receive and Transmit Frequencies** not contained in Frequency Code Table 1, page 12.
- **Wide or narrow band transmit operation** can be set per channel. Refer to the section FCC Narrowband Mandate to see if your radio is capable of wideband transmit operation.

Additional PC programmable features available to models JMX-144D / 444D / 446D ONLY include:

- **Scan Channel Options** include scan resume delay time, busy channel blocking, last active channel beeps, and priority scanning options.
- **Squelch Tightener** Receiver carrier squelch can be adjusted UP or DOWN.
- **Transmit Power** (JMX-144D and JMX-444D Only)
- **Transmit Time Out** can be changed or disabled.

- **Monitor Lock Out** can be set to prevent monitoring of the channel, only broadcasts with the correct QC or DQC code can be heard.
- **Transmit Inhibit on Busy Channel** can be set to prevent transmitting when a broadcast is present on the receiver that does not carry the correct code.
- **Receive Squelch Tone** sounds at the end of each received transmission.
- **Transmit Clear To Talk Beep** sounds after the PTT has been pressed.
- **Power Saver** time can be set or disabled.
- **Field Programming** can be disabled.
- **4-Hour Inactivity Turn-Off** The radio can be set to turn off automatically if not used for over 4 hours.
- **2-Tone Encode and Decode** The radio can be programmed to send and receive 2-tone paging.

NOAA WEATHER RADIO

SELECTING YOUR LOCAL NOAA WEATHER FREQUENCY

VHF models of the JMX "D-Series" radio can hear weather forecasts from the National Weather Service which are broadcast on one of the seven NOAA weather frequencies.



The radio is shipped from the factory without a NOAA frequency selected. Before using any of the NOAA weather features on your VHF radio you must first select the local NOAA frequency.

1. Follow the steps in FIG-4 at right to place the radio into the Weather Frequency Select mode.
2. The radio will scan to the 1st NOAA frequency where a broadcast is present. The display will light a single segment to indicate the NOAA frequency per FIG-5.
3. Monitor the channel for a few minutes to be sure it is the broadcast for your local area.
4. Press the Channel button to scan for the presence of any other NOAA broadcasts, monitoring each broadcast and noting the frequency as indicated by the display.
5. Using the Channel button, select the local NOAA frequency you would like your radio to operate on.
6. Turn the radio off by pressing the Volume Down / Off button.
7. When the radio is turned back on all weather features will operate on the selected NOAA frequency.

NOAA WEATHER CHANNEL

Once a NOAA weather frequency has been selected on your VHF model radio, a channel is created for listening to National Weather Service broadcasts.

Press the Channel button to step through your radio channels. The NOAA Weather Channel will be after your last channel, and the display will light the segment representing the selected NOAA frequency. If you wish to exclude the NOAA Weather Channel feature, it can be turned off through Field Programming.

WEATHER ALERT

Once a NOAA weather frequency has been selected on your VHF model radio it will listen for emergency broadcasts from the National Weather Service, regardless of which channel you are on.

An alert tone will sound in the speaker, the display will show an "A" (as shown), and the National Weather Service emergency broadcast will be heard - advising you of threatening weather conditions.



NOTE: NOAA sends a test alert tone once each week. Your radio will respond to this alert.

Pressing the Channel button will return you to your normal operating channel.

If you do not desire Weather Alert, it can be turned off through Field Programming, refer to page 13.



FIG-4: TO SELECT YOUR LOCAL NOAA WEATHER FREQUENCY

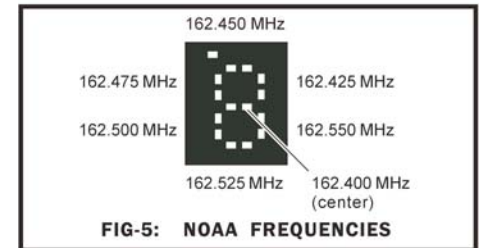
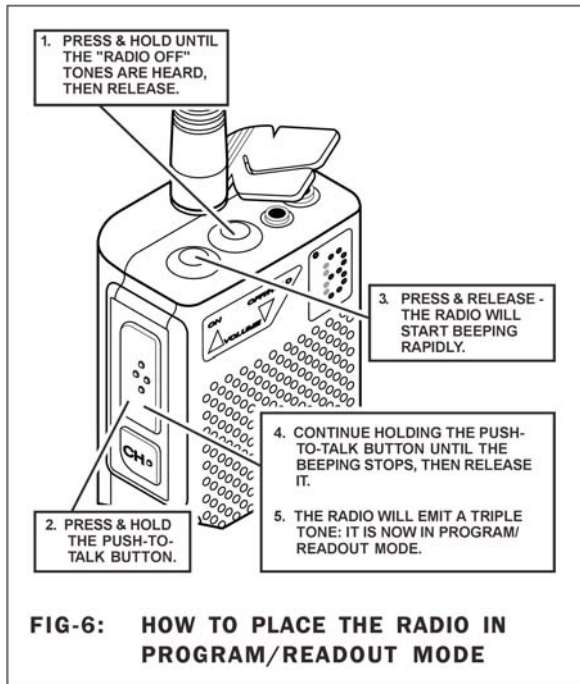

FIG-5: NOAA FREQUENCIES

RADIO PROGRAMMING

IMPORTANT

To talk to other users in your group, all radios must be set to the same frequency and Interference Eliminator codes.



HOW TO READOUT FIELD PROGRAMMED FREQUENCY & TONE CODES

In our example channel 3 of a JMX-446D radio is programmed to operate on the "Brown Dot" frequency of 464.500 MHz (Frequency code "04") with 100.0 Hz tone (Tone code "12").

P

1. Place the radio into Program / Readout Mode by following the instructions in FIG- 6 at left. A "P" will appear on the LED display as you enter program mode.

2-5-9-
1-9-9-
0-4-4-

2. Release the Push-to-talk button after the beeping has stopped. The radio will display a series of six characters for Radio Identification, with each character separated by a hyphen. The 1st two characters indicate the model number, the 3rd and 4th characters indicate the radio type, and the 5th and 6th characters indicate the firmware revision.

In this example: Model: 25
Radio Type: 19
Firmware Revision: 04

NOTE: Radio models with firmware revisions prior to 14.01 do not display the Radio Identification sequence.

1-
3-

3. After the Radio Identification has been displayed the digit 1 will appear, followed by a hyphen, and the radio will emit a triple beep indicating that the radio is in program mode and channel 1 is selected.

0-4-4-
1-2-

4. Press the Channel button to select the channel to be read out. The channel number will appear briefly on the display as you step through the channels. When you have settled on a channel a hyphen will appear across the center of the display to indicate that it is ready for readout.

5. Press and release the On / Volume Up button. The radio will begin to display a series of four digits; with each digit separated by a hyphen.

The 1st and 2nd digits indicate the frequency code; see Table 1 on page 12. The 3rd and 4th digits indicate the tone code; see Table 2 on page 13.

JMX-144D / 446D / 444D Models Only

If a 5th digit is displayed, the channel has been programmed for DQC and the last three digits indicate the DQC code; see Table 3 on page 13.

If more than 5 digits are displayed refer to page 17.

E

6. If the channel is PC-programmed for any frequency not listed in Table 1 on page 12, an error tone will sound and an "E" will appear on the display.

7. To readout another channel, repeat steps 4 through 6.

8. Turn the radio OFF and then ON again—the radio is now ready to use.

RADIO PROGRAMMING

HOW TO FIELD PROGRAM FREQUENCY & TONE CODES

To match other radios, the owner can select Frequency and Tone Codes from **Tables 1, 2 and 3 on pages 12 and 13.**

In our example we will program channel 3 of a JMX-446D to operate on the "Brown Dot" frequency of 464.500 MHz (Frequency code "04") with 100.0 Hz tone (Tone code "12").

04

1. Refer to Table 1 on page 12 to determine the two digit frequency code and write it down.

12

2. Refer to Table 2 on page 13 to determine the two digit tone code for 100.0 Hz and write it down.

P

3. Place the radio into Program / Readout Mode by following the instructions in FIG-6 on page 10. A "P" will appear on the LED display as you enter program mode.

**2598
4898
8898**

4. Release the Push-to-talk button after the beeping has stopped. The radio will display a series of six characters for Radio Identification, with each character separated by a hyphen. The 1st two characters indicate the model number, the 3rd and 4th characters indicate the radio type, and the 5th and 6th characters indicate the firmware revision.

In this example: Model: 25
Radio Type: 19
Firmware Revision: 04

NOTE: Radio models with firmware revisions prior to 14.01 do not display the Radio Identification sequence.

1-

5. After the Radio Identification has been displayed the digit 1 will appear followed by a hyphen, and the radio will emit a triple beep indicating that the radio is in program mode and channel 1 is selected.

3-

6. Press the Channel Selector button to select the channel to be programmed. The channel number will show briefly on the channel display as you step through the channels. When you have settled on a channel the display will show a hyphen to indicate that it is ready for programming, except the JMX-111D which is a 1- channel radio.

FREQUENCY CODE

0-

7. Enter the 1st digit of the frequency code by clicking the PTT button until the channel display shows the desired number. Pause - the radio will sound a low tone and show a hyphen across the center of the display to indicate that it is ready to accept the next digit.

4-

8. Enter the 2nd digit of the frequency code by clicking the PTT button until the channel display shows the desired number. Pause - the radio will sound a low tone and show a hyphen across the center of the display to indicate that it is ready to accept the next digit.

1-

9. Enter the 1st digit of the tone code (or 1st digit of the DQC code) by clicking the PTT button until the channel display shows the desired number. Pause - the radio will sound a low tone and show a hyphen on the display to indicate that it is ready to accept the next digit

2-

10. Enter the 2nd digit of the tone code (or 2nd digit of the DQC code) by clicking the PIT button until the channel display shows the desired number. Pause - the radio will sound a low tone and show a hyphen on the display to indicate that it is ready to accept the next digit

TONE CODE

11. **JMX-144D / 444D / 446D Models Only**
FOR DQC CODES ONLY -Enter the 3rd digit of the DQC code by clicking the PIT button until the channel display shows the desired number. Pause - the radio will sound a low tone and show a hyphen on the display to indicate that it is ready to accept the next digit

12. Press and release the On / Volume Up to **SAVE** your programming entry. The LED display will briefly show the channel number you have just programmed and the radio will sound a triple beep to indicate that programming was successful.

E

NOTE: An error tone will sound if you attempt to save an incorrect code and an "E" will appear on the display. Turn the radio OFF, check the digits you are attempting to enter, then start over.

13. To program another channel, repeat steps 6 through 12.

14. Turn the radio OFF and then ON again—the radio is now ready to use.

NOTES:

- a. **YOU MUST** enter 'No Tone interference eliminator code '44"' to match radios not having tone codes. Refer to Table 2 on page 13.
- b. If the radio does not sound a confirming triple tone when you attempt to enter Program / Readout Mode, the radio was factory or dealer customized to disable programming. Consult the radio owner or your dealer.

RADIO IDENTIFICATION

SELECT CHANNEL

RADIO PROGRAMMING

TABLE 1: PROGRAMMABLE FREQUENCY CODES

| VHF MURS ** | | | |
|--------------------|---------------------|------------|------------|
| Code No. | MHz | Color Dot | Band Width |
| 01 | 154.6000 | Green Dot | 25.0 |
| 02 | 154.5700 | Blue Dot | 25.0 |
| 19 | 151.8200 | MURS | 12.5 |
| 20 | 151.8800 | MURS | 12.5 |
| 21 | 151.9400 | MURS | 12.5 |
| 22 | 154.6000 | MURS/Green | 12.5 |
| 23 | 154.5700 | MURS/Blue | 12.5 |
| 00 | DELETE Code* | | |

| VHF Business Band | | | |
|--------------------------|---------------------|------------|------------|
| Code No. | MHz | Color Dot | Band Width |
| 03 | 151.6250 | Red Dot | 12.5 † |
| 04 | 151.9550 | Purple Dot | 12.5 † |
| 05 | 151.9250 | | 12.5 † |
| 06 | 154.5400 | | 12.5 † |
| 07 | 154.5150 | | 12.5 † |
| 08 | 154.6550 | | 12.5 † |
| 09 | 151.6850 | | 12.5 † |
| 10 | 151.7150 | | 12.5 † |
| 11 | 151.7750 | | 12.5 † |
| 12 | 151.8050 | | 12.5 † |
| 13 | 151.8350 | | 12.5 † |
| 14 | 151.8950 | | 12.5 † |
| 15 | 154.4900 | | 12.5 † |
| 16 | 151.6550 | | 12.5 † |
| 17 | 151.7450 | | 12.5 † |
| 18 | 151.8650 | | 12.5 † |
| 24 | 151.7000 | | 12.5 |
| 25 | 151.7600 | | 12.5 |
| 26 | 152.7000 | | 12.5 † |
| 00 | DELETE Code* | | |

| UHF Business Band | | | |
|--------------------------|----------|-------------|------------|
| Code No. | MHz | Color Dot | Band Width |
| 01 | 467.7625 | J | 12.5 † |
| 02 | 467.8125 | K | 12.5 † |
| 03 | 464.5500 | Yellow Dot | 12.5 † |
| 04 | 464.5000 | Brown Dot | 12.5 † |
| 05 | 467.8500 | Silver Star | 12.5 † |
| 06 | 467.8750 | Gold Star | 12.5 † |
| 07 | 467.9000 | Red Star | 12.5 † |
| 08 | 467.9250 | Blue Star | 12.5 † |
| 09 | 469.2625 | | 12.5 † |
| 10 | 462.5750 | White Dot | 12.5 † |
| 11 | 462.6250 | Black Dot | 12.5 † |
| 12 | 462.6750 | Orange Dot | 12.5 † |
| 13 | 464.3250 | | 12.5 † |
| 14 | 464.8250 | | 12.5 † |
| 15 | 469.5000 | | 12.5 † |
| 16 | 469.5500 | | 12.5 † |
| 17 | 463.2625 | | 12.5 † |
| 18 | 464.9125 | | 12.5 † |
| 19 | 464.6000 | | 12.5 † |
| 20 | 464.7000 | | 12.5 † |
| 21 | 462.7250 | | 12.5 † |
| 22 | 464.5000 | Brown Dot | 12.5 |
| 23 | 464.5500 | Yellow Dot | 12.5 |
| 24 | 467.7625 | J | 12.5 |
| 25 | 467.8125 | K | 12.5 |
| 26 | 467.8500 | Silver Star | 12.5 |

Per FCC rules and regulations, a given radio must not be programmed to contain a mix of both VHF Business Band and VHF MURS frequencies.

| UHF Business Band | | | |
|--------------------------|----------|-----------|------------|
| Code No. | MHz | Color Dot | Band Width |
| 27 | 467.8750 | Gold Star | 12.5 |
| 28 | 467.9000 | Red Star | 12.5 |
| 29 | 467.9250 | Blue Star | 12.5 |
| 30 | 461.0375 | | 12.5 |
| 31 | 461.0625 | | 12.5 |
| 32 | 461.0875 | | 12.5 |
| 33 | 461.1125 | | 12.5 |
| 34 | 461.1375 | | 12.5 |
| 35 | 461.1625 | | 12.5 |
| 36 | 461.1875 | | 12.5 |
| 37 | 461.2125 | | 12.5 |
| 38 | 461.2375 | | 12.5 |
| 39 | 461.2625 | | 12.5 |
| 40 | 461.2875 | | 12.5 |
| 41 | 461.3125 | | 12.5 |
| 42 | 461.3375 | | 12.5 |
| 43 | 461.3625 | | 12.5 |
| 44 | 462.7625 | | 12.5 |
| 45 | 462.7875 | | 12.5 |
| 46 | 462.8125 | | 12.5 |
| 47 | 462.8375 | | 12.5 |
| 48 | 462.8625 | | 12.5 |
| 49 | 462.8875 | | 12.5 |
| 50 | 462.9125 | | 12.5 |
| 51 | 464.4875 | | 12.5 |
| 52 | 464.5125 | | 12.5 |

**** MURS frequencies – The 5 MURS frequencies *do not* require an FCC license. All other frequencies *require* an FCC license. See page 19 for license information.**

| UHF Business Band | | | |
|--------------------------|---------------------|-----------|------------|
| Code No. | MHz | Color Dot | Band Width |
| 53 | 464.5375 | | 12.5 |
| 54 | 464.5625 | | 12.5 |
| 55 | 466.0375 | | 12.5 |
| 56 | 466.0625 | | 12.5 |
| 57 | 466.0875 | | 12.5 |
| 58 | 466.1125 | | 12.5 |
| 59 | 466.1375 | | 12.5 |
| 60 | 466.1625 | | 12.5 |
| 61 | 466.1875 | | 12.5 |
| 62 | 466.2125 | | 12.5 |
| 63 | 466.2375 | | 12.5 |
| 64 | 466.2625 | | 12.5 |
| 65 | 466.2875 | | 12.5 |
| 66 | 466.3125 | | 12.5 |
| 67 | 466.3375 | | 12.5 |
| 68 | 466.3625 | | 12.5 |
| 69 | 467.7875 | | 12.5 |
| 70 | 467.8375 | | 12.5 |
| 71 | 467.8625 | | 12.5 |
| 72 | 467.8875 | | 12.5 |
| 73 | 467.9125 | | 12.5 |
| 74 | 469.4875 | | 12.5 |
| 75 | 469.5125 | | 12.5 |
| 76 | 469.5375 | | 12.5 |
| 77 | 469.5625 | | 12.5 |
| 00 | DELETE Code* | | |

*** 2-digit Frequency placeholder code (Refer to “How to Delete a Channel” on page 13)**

† Frequency code was 25 KHz bandwidth prior to the 2013 FCC Narrowband Mandate.

RADIO PROGRAMMING

TABLE 2: INTERFERENCE ELIMINATOR PROGRAMMABLE QC TONE

| Code | Hz | Code | Hz | Code | Hz |
|------|--------|------|-------|------|---------|
| 01 | 67.0 | 18 | 123.0 | 35 | 225.7 |
| 02 | 71.9 | 19 | 127.3 | 36 | 233.6 |
| 03 | 74.4 | 20 | 131.8 | 37 | 241.8 |
| 04 | 77.0 | 21 | 136.5 | 38 | 250.3 |
| 05 | 79.7 | 22 | 141.3 | 39 | 69.4 |
| 06 | 82.5 | 23 | 146.2 | 40 | 159.8 |
| 07 | 85.4 | 24 | 151.4 | 41 | 165.5 |
| 08 | 88.5 | 25 | 156.7 | 42 | 171.3 |
| 09 | 91.5 | 26 | 162.2 | 43 | 177.3 |
| 10 | 94.8 | 27 | 167.9 | 44 | No Tone |
| 11 | 97.4 | 28 | 173.8 | 45 | 183.5 |
| 12 | 100.0 | 29 | 179.9 | 46 | 189.9 |
| 13 | 103.5 | 30 | 186.2 | 47 | 196.6 |
| 14 | 107.2 | 31 | 192.8 | 48 | 199.5 |
| 15 | 110.9 | 32 | 203.5 | 49 | 206.5 |
| 16 | 114.8 | 33 | 210.7 | 50 | 229.1 |
| 17 | 118.8 | 34 | 218.1 | 51 | 254.1 |
| 00 | Delete | | | | |

TABLE 3: DIGITAL INTERFERENCE ELIMINATOR PROGRAMMABLE DQC TONE

| CODE NUMBERS | | | | | | |
|--------------|-----|-----|-----|-----|-----|-----|
| 023 | 074 | 165 | 261 | 356 | 462 | 631 |
| 025 | 114 | 172 | 263 | 364 | 464 | 632 |
| 026 | 115 | 174 | 265 | 365 | 465 | 645 |
| 031 | 116 | 205 | 266 | 371 | 466 | 654 |
| 032 | 122 | 212 | 271 | 411 | 503 | 662 |
| 036 | 125 | 223 | 274 | 412 | 506 | 664 |
| 043 | 131 | 225 | 306 | 413 | 516 | 703 |
| 047 | 132 | 226 | 311 | 423 | 523 | 712 |
| 051 | 134 | 243 | 315 | 431 | 532 | 723 |
| 053 | 143 | 244 | 325 | 432 | 546 | 731 |
| 054 | 145 | 245 | 331 | 445 | 565 | 732 |
| 065 | 152 | 246 | 332 | 446 | 606 | 734 |
| 071 | 155 | 251 | 343 | 452 | 612 | 743 |
| 072 | 156 | 252 | 346 | 454 | 624 | 754 |
| 073 | 162 | 255 | 351 | 455 | 627 | |

HOW TO DELETE A CHANNEL

1. Follow the instructions in FIG-6 on page 10 to place the radio in the Program / Readout Mode.
2. Using the **CHANNEL** button and the LED display on the front of the radio, select the channel to be deleted.
3. Enter 4-digit code "0000" as described in the "How to Field Program Frequency & Tone Codes" section on page 11.
4. When all four digits are programmed, press and release the On / Volume Up to **SAVE** your programming entry. The LED display will briefly show the channel number you have just deleted and the radio will sound a triple beep to indicate that channel deletion was successful.
5. To delete another channel, repeat steps 2 through 4.
6. Turn the radio OFF and then ON again—the radio is now ready to use.
7. The remaining channels are in the same sequence and will retain their same channel number. The Channel Selector will skip over the deleted channel numbers.

NOTE: If all channels are deleted the radio will not operate, instead it will turn on in Field Program mode to allow entry of a valid frequency and tone code.

HOW TO FIELD PROGRAM RADIO OPTIONS

1. Follow the instructions in FIG-6 on page 10 to place the radio in the Program / Readout Mode.
2. Using the PTT (push-to-talk) button and the LED display, enter the single digit code from Table 4 below for the option to be programmed.
3. Pause—the display will change and show a hyphen, you will also hear a short low tone.
4. Press and release the On / Volume Up to **SAVE** your programming entry. The radio will sound a triple beep to indicate that programming was successful.
5. Turn the radio OFF and then ON again—the radio is now ready to use.

TABLE 4: Radio Option Codes

| Option | Code | |
|----------------------|------------|---|
| Turn Channel Scan | ON | 1 |
| Turn Channel Scan | OFF | 2 |
| Turn Weather Channel | ON | 3 |
| Turn Weather Channel | OFF | 4 |
| Turn Weather Alert | ON | 5 |
| Turn Weather Alert | OFF | 6 |
| Turn Speaker Beep | ON | 7 |
| Turn Speaker Beep | OFF | 8 |

BATTERIES

FIG-7: BATTERY ACCESS AND INSTALLATION

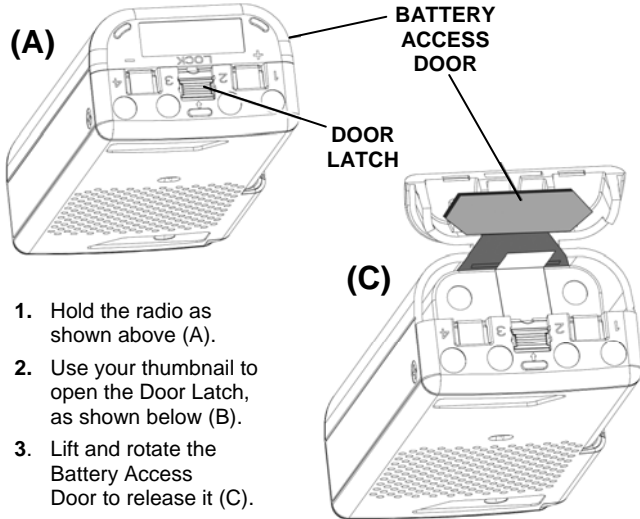

1. Hold the radio as shown above (A).
2. Use your thumbnail to open the Door Latch, as shown below (B).
3. Lift and rotate the Battery Access Door to release it (C).

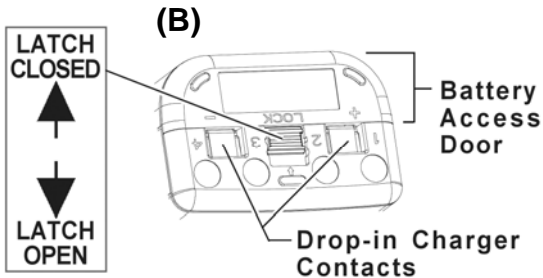

4. Use the Pull-tab to pull the battery pack out of the case (D).
5. Insert the replacement battery pack, being certain to POSITION IT RELATIVE TO THE CASE AS SHOWN IN (D). Push the Battery Pack in as far as possible.
6. Replace the Battery Access Door. Secure it by closing the Door Latch as shown in (B).
7. Be certain to firmly lock the Door Latch as shown in (B).

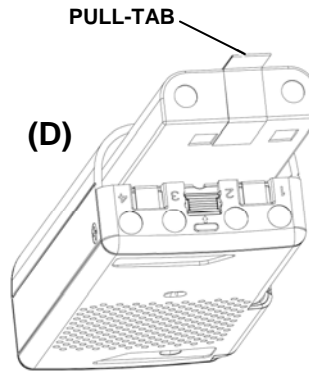

OPTIONAL CHARGING ACCESSORIES

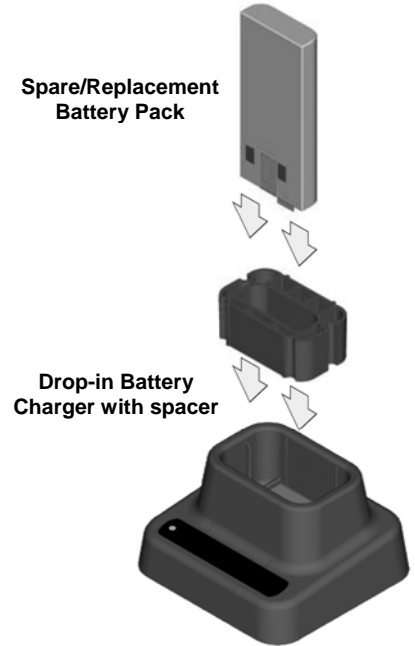

JOBKOM JMX Accessories:

- BPS-6N-MH** Spare Battery Pack
- BCJS-AD** Drop-In Charger Adapter
- BCJS-4AD** 4-Unit Gang Charger

See Accessories on page ii.

BATTERIES

CAUTION: Use only RITRON-supplied chargers; using other chargers may cause fire or explosion, or otherwise damage the radio.

CHARGING

The JMX "D-Series" radio is powered by a rechargeable battery pack. Because the battery pack loses its charge during storage and shipment, fully charge it before first use. To ensure peak radio performance for the next day, charge the battery overnight after each day of use. It completely charges in about ten hours.

TO CHARGE THE BATTERY WITH A RITRON CUBE CHARGER

Plug the charger cord into the charge jack (marked "CHG") on top of the radio. Then plug the cube into a 110 VAC outlet. The green lamp lights while the battery is charging, and should go out only when the cube or cord is unplugged.

TO CHARGE THE BATTERY WITH A RITRON DROP-IN CHARGER

Two charger contacts, visible through the radio case bottom, permit charging the battery with an optional Ritron drop-in charger. The battery pack may be either removed from the radio case for charging, or charged inside the radio case.

Each drop-in charger comes with a spacer to permit charging a "spare" battery while the radio is being used.

To use the drop-in charger, plug it into a 110 VAC outlet. Set either the radio with the battery installed, or only the battery with the battery spacer, into the charger. Refer to the illustration in OPTIONAL CHARGING ACCESSORIES on the previous page. Each battery contact must rest on a charger contact pin.

NOTE:

Battery pack life averages one year. Follow these guidelines to maximize service life:

- CONDITION battery packs once a month as directed in Battery Maintenance & Conditioning, at right.
- CONDITION batteries that are run down.
- CHARGE batteries for 16 hours before storage, and for 16 hours once a month thereafter.
- DO NOT overcharge batteries. Unplug the cube charger after 16 hours to avoid overcharging.
- DO NOT charge batteries in temperatures colder than about 45°F. Charging batteries in temperatures above 95°C does not harm them, but can reduce charge capacity.

BATTERY MAINTENANCE & CONDITIONING

Due to the extended run time of the JMX "D-Series" radios, some users may never fully discharge the battery pack during normal use. Achieve maximum battery life by fully discharging the battery periodically to condition it.

After exposing the battery pack to many cycles of not fully discharging it before recharging, the radio may exhibit reduced battery capacity. This reduced capacity is evident when, after several hours of use, battery voltage drops while the radio is transmitting, causing the radio to emit a low battery warning tone.

Condition battery packs by the following procedure as either a preventive measure, or if you suspect reduced capacity:

TO CONDITION THE BATTERY PACK:

1. Use your radio throughout a normal work day without charging.
2. • Press and hold the On / Volume Up and Volume Down / Off buttons simultaneously for 8 seconds to place the radio in "no squelch" mode.
• Release both buttons when you hear the radio beep rapidly; it will then emit a loud "rushing" noise. Press On / Volume Up to maximize this noise.
3. Put the radio away in a secure place (possibly a desk drawer), where nothing can press against the buttons to accidentally turn it off or cause it to transmit. Allow the radio to run until it shuts off when the battery is completely discharged. A typical battery pack may require up to 8 hours to completely discharge.
4. When the radio has shut off, charge it overnight for 12-14 hours. The battery will be ready for use with renewed capacity.

NOTE: A new battery must be charged and discharged several times before it can reach its maximum charge capacity.

!! CAUTIONS – ALL RADIOS !!

OBSERVE CAUTION IN THE FOLLOWING ENVIRONMENTS TO MAXIMIZE THE LIFE OF YOUR RADIO EQUIPMENT:

MOISTURE: JMX “D-Series” radios are not waterproof. DO NOT directly expose them to rain or excessive moisture.

CHEMICALS: Detergents, alcohol, aerosol sprays or petroleum products can damage the radio case. DO NOT use petroleum solvents of any kind; use a soft cloth moistened with water to clean the case.

EXTREME HEAT: High temperatures can damage the battery and other components. DO NOT expose the units to extreme heat or leave them in direct sunlight.

LOW TEMPERATURES: The capacity of the battery is greatly reduced in extreme cold. When using the unit in very cold environments, periodically warm the radio under your coat.

EXCESSIVE TRANSMISSIONS: Maximum drain on battery power occurs when you are transmitting. DO NOT hold the Push-To-Talk switch down longer than necessary during transmission intervals. DO NOT reduce battery service life by attempting to power a radio with a depleted battery; always charge batteries overnight after each day of use.

VIBRATION / SHOCK: Although your JMX “D-Series” radio is designed to be rugged, it will not survive excessive abuse. Avoid dropping the radio.

NOTE: The optional MH-A holster provides added protection from weather and shock.

EXPOSURE TO RADIO FREQUENCY ENERGY

The JMX/SST Series hand held radios generate RE electromagnetic energy during transmit mode. The transmit mode is active when the PTT switch is depressed. This radio is designed for, and classified as, “Occupational Use Only”, meaning that it must be used only during the course of employment by individuals who are aware of the hazards and the ways to minimize such hazards. This series of radios is NOT intended for use by the “General Population” in an uncontrolled environment.

When used as directed, this series of radios is designed to comply with the FCC’s RF exposure limits for “Occupational Use Only”. In addition, they are designed to comply with the following Standards and Guidelines:

- FCC OET Bulletin 65, Edition 97-01, Supplement C, Evaluating Compliance with FCC Guidelines for Human Exposure to Radio Frequency Electromagnetic Fields.
- American National Standards Institute (C95.1- 1992), IEEE Standard for Safety Levels with Respect to Human Exposure to Radio Frequency Electromagnetic Fields, 3 kHz to 300 GHz.
- American National Standards Institute (C95.3- 1992), IEEE Recommended Practice for the Measurement of Potentially Hazardous Electromagnetic Fields-RF and Microwave.

To ensure that exposure to RF electromagnetic energy is within the FCC allowable limits for occupational use, always adhere to the following guidelines:

- Use only the antenna(s) available from RITRON for these models. **DO NOT** attempt to substitute any other antenna. **DO NOT** operate the radio without an antenna.
- Keep talk times as short and infrequent as possible. **DO NOT** depress the PTT button when not actually wishing to transmit. These radios are equipped with an internal timer to limit continuous transmit times. **DO NOT** exceed a 50% transmit duty cycle.
- When transmitting, hold the radio in front of the mouth at a distance of at least 4 inches. **DO NOT** hold the radio in such a manner that the antenna is next to, or touching, exposed parts of the body, especially the face or eyes while transmitting.
- In belt mounted applications, when transmitting, remove the radio from the belt and hold away from the body at least 4 inches.
- When using external headset accessories, hold the unit away from the body at least 4 inches while transmitting.
- **DO NOT** allow children to operate the radio.

SPECIAL APPLICATIONS

HOW TO FIELD PROGRAM TWO-TONE ENCODE CODES

THIS FEATURE AVAILABLE ON JMX-144D / 444D / 446D MODELS ONLY

For special applications, it is possible to use your Ritron portable radio or base station for remote control applications; such as opening or closing a gate remotely (see **Ritron GateGuard** at www.ritron.com/pdf/gg_07.pdf). This application requires you to program your radio for 2-Tone encode operation.

The user can field program each channel with one of the **9 pre-set 2-Tone Codes** specified in **Table 5**. These codes correspond to field programmable 2-Tone Codes available in the RITRON 6-Series OUTPOST Callbox. In our example we will program a UHF radio to operate with 2-Tone **Code #94**.

Important Note:

You can **ADD** a 2-Tone Code to a channel if the Frequency Code and Tone Code are not changed. Changing the **Frequency Code** or **Tone Code** of a channel will **ERASE** any **2-Tone Code** programmed on that channel. You must **FIRST** re-program the channel to the desired Frequency Code and Tone Code and then **SAVE** the entry by pressing the On / Volume Up button, then you may enter your 2-Tone Code, remember you must also **SAVE** this entry by pressing the On / Volume Up button.

1. Refer to **Table 5** to determine the 2 digit, 2-Tone Code(s) you wish to program into each specific channel.
2. Follow the instructions in Fig 6, page 10 to place the radio in the "Program/Readout Mode".
3. Using the channel button and the LED display on the radio, select the channel number you want to program a 2-Tone Code into.

┌ 2-TONE CODE ┐



4. Enter the 1st digit of the 2-Tone code by clicking the PTT button until the program display shows the desired number. Pause—the radio will sound a low tone and show a hyphen across the display to indicate that it is ready to accept the next digit.



5. Enter the 2nd digit of the 2-Tone code by clicking the PTT button until the program display shows the desired number. Pause—the radio sounds a low tone and will show a hyphen across the display.

6. After you have entered both digits, press and release the On / Volume Up button to **SAVE** the entry. The LED display will briefly show the channel number you have just programmed and then a hyphen, the radio will sound a triple beep to indicate that programming was successful

An **ERROR** tone will sound if you attempt to save an incorrect code, an "E" will appear on the LED display. Check the digits you are attempting to program and start over.

7. You may program each channel with the same or a different 2-Tone Code by repeating steps 3-6.
8. Turn the radio OFF and then ON again for normal operation. See *2-Tone ENCODE Operation* for how to send the 2-Tone Code on your radio.



If more than 5 digits are displayed during readout, the radio has been programmed for 2-Tone Encode. The frequency and tone codes will be displayed, followed by a "C", then the radio will display the 2-Tone code; see **Table 5**. In this example a UHF radio was programmed to operate on the "Brown Dot" **Frequency Code 04** (464.500 MHz) with **Tone Code 12** (100.0 Hz) and **2-Tone encode Code 94**.

Readout Sequence



Frequency Code Tone Code 2-Tone Code

2-TONE ENCODE OPERATION

To send a 2-Tone Code, select a channel that has been programmed for 2-Tone encode. Push and hold the channel button until you hear the 2-Tone Code being sent, then release the channel button.

TABLE 5: PROGRAMMABLE 2-TONE ENCODE CODES

| Code No. | Code No. | Code No. |
|----------|----------|----------|
| 91 | 94 | 97 |
| 92 | 95 | 98 |
| 93 | 96 | 99 |

TROUBLESHOOTING

NOTES

- Try a battery pack from a working radio. If the radio in question works with that pack, the original battery is suspect.
 - Charge the suspect battery as recommended in this manual. If this original battery cannot power the radio, try charging it again with another charger. If the battery still doesn't hold a charge, the pack should probably be replaced.
 - If the battery appears to be 'good' after using the second charger, the first charger may be faulty. Contact a dealer or Ritron about an accessory that is not operating properly.
- Reception can often be improved if you relocate by a short distance. This effect is more noticeable inside buildings.
 - The range for JMX radio is about two miles, line-of-sight.
- If your radio does not detect calls from other radios on the channel, turn off Quiet Call by pressing and holding both volume buttons at the same time—a double beep indicates Quiet Call is off.
- Without use of a repeater. To hear a call, select a channel programmed to receive the caller's transmit frequency. To call another unit, select a channel programmed to transmit the other radio's receive frequency.
 - Using a repeater. A radio channel can hold two separate operating frequencies, one for receive and one for transmit. Your channel must work with the repeater's transmit and receive frequencies.
- Maximum power drain occurs when the radio transmits, so don't hold down the PTT more than needed to transmit.
 - Battery power is used while the handheld is left on to receive calls. If practical, switch off the unit.
- Battery capacity is greatly reduced in extreme cold.
 - To use the radio in very cold weather, periodically warm it under your coat if possible.
 - An optional remote speaker / microphone allows keeping the radio under your coat while transmitting and receiving.
- To "talk" with each other, radios must be programmed identically for Quiet Call code, as well as frequency. Each code is unique; radios respond only to the code programmed.
 - Press and hold both volume buttons at the same time.
A single beep indicates Quiet Call squelch is on.
A double beep indicates Quiet Call squelch is off.

CHART

If you have trouble operating the handheld, review the Controls & Operation, pages 3 through 8. If you think the radio is malfunctioning, check the list below.

| Problem | Possible Solutions |
|--|--|
| GENERAL | |
| The radio does not work at all. | <ul style="list-style-type: none"> • Make sure that the battery is installed correctly, as shown in FIG-7, page 14. • Recharge or replace the battery. (See pages 14 & 15.) |
| Operating features do not work exactly as expected. | <ul style="list-style-type: none"> • The radio has been dealer programmed for customized operation. (Consult dealer.) |
| Reception is poor. | <ul style="list-style-type: none"> • Move to a different location. (See Note 2.) • Confirm the proper antenna is connected to the radio. (See page 3, Antenna) |
| You cannot hear calls from other radios. | <ul style="list-style-type: none"> • Turn off Quiet Call (coded) squelch. (See Note 3.) • Ensure radio receives on the same frequency as the caller transmits. (See Note 4.) • Recharge the battery. (See Note 1.) |
| Your calls cannot be heard in other radios. | <ul style="list-style-type: none"> • Make sure that your radio transmits on the receive frequency of the radio(s) you want to call. (See Note 4.) • Recharge the battery. |
| BATTERY | |
| Battery loses charge sooner than expected. | <ul style="list-style-type: none"> • Review battery charging instructions, page 15. • Conserve the battery. (See Note 5.) • If the radio is used in extreme cold, warm the radio under your coat. (See Note 6.) • Replace the battery; see FIG-7, page 14. (See Note 1.) |
| ERROR TONES | |
| An error tone sounds when the radio is first switched on. | <ul style="list-style-type: none"> • See "Error Tones" on page 5 |
| An error tone occurs while transmitting. | <ul style="list-style-type: none"> • Refer to "Transmitter Time-Out," page 6. • Refer to "Recharge Battery Alert," page 6. |
| QUIET CALL | |
| You cannot screen out calls from users outside of your Quiet Call group. | <ul style="list-style-type: none"> • Make sure that the channel is programmed with Quiet Call. • Activate coded squelch. (See Note 7.) |
| You cannot hear Quiet Call messages while in Quiet Call (coded) squelch. | <ul style="list-style-type: none"> • Confirm that the channel is programmed to detect the same code as the calling radio(s) transmits. (See Note 7.) |
| Others in your Quiet Call group cannot hear your Quiet Call messages. | <ul style="list-style-type: none"> • Verify that you transmit the same code as the radio(s) you call are programmed to detect. (See Note 7.) |

FCC LICENSE REQUIRED

FCC REGULATIONS

LICENSING —

The FCC requires the owners of the radios to obtain a station license before using them.

The station licensee is responsible for ensuring that transmitter power, frequency and deviation are within the limits specified by the station license. The station licensee is also responsible for proper operation and maintenance of the radio equipment. This includes checking the transmitter frequency and deviation periodically, using appropriate methods.

To get an FCC license for VHF or UHF frequencies, submit FCC application Form 600 as indicated in the block at right. Your Ritron dealer can help you with this process.

SAFETY STANDARDS —

The FCC (with its action in General Docket 79-144, March 13, 1985) has adopted a safety standard for human exposure to radio frequency electromagnetic energy emitted by FCC regulated equipment.

Ritron observes these guidelines and recommends that you do also:

- DO NOT hold the radio so that the antenna is very close to or touching exposed parts of the body, especially the face or eyes, while transmitting. Keep the radio vertical, four inches away while talking into the front panel.
- DO NOT press the Push-To-Talk except when you intend to transmit.
- DO NOT operate radio equipment near electrical blasting caps or in an explosive atmosphere.
- DO NOT allow children to play with any radio equipment that contains a transmitting device.
- Repair of Ritron products should be performed only by Ritron authorized personnel.

SERVICE

Federal law prohibits you from making any internal adjustments to the transmitter, and / or from changing transmit frequencies unless you are specifically designated by the licensee.

If your radio equipment fails to operate properly, or you wish to have the radio programmed, contact your authorized dealer or Ritron.

RITRON, INC.
Repair Department
505 West Carmel Drive
Carmel, IN 46032 USA

Phone: 317-846-1201
FAX: 317-846-4978
Email: customer_service@ritron.com

HOW TO OBTAIN AN FCC RADIO LICENSE

Federal Communications Commission (FCC) Licensing Information

Because your Ritron radio operates on Private Land Mobile frequencies, it is subject to the Rules and Regulations of the FCC, which requires all operators of these frequencies to obtain a station license before operating their equipment. Make application for your FCC license on FCC Forms 600 and 159.

*To have forms and instructions faxed to you by the FCC, call the **FCC Fax-On-Demand** system at **202-418-0177** from your fax machine; request Document 000600 & Form 159.*

*To have Document 000600 & Form 159 mailed to you, call the **FCC Forms Hotline** at **800-418-FORM** (800-418-3676).*

*For **help with questions** concerning the license application, contact the FCC at **888-CALL-FCC** (888-225-5322).*

You must decide which radio frequency(ies) you can operate on before filling out your application; refer to Table 1 on page 12 of this manual.

*For **help determining your frequencies**, call Ritron at **800-USA-I-USA** (800-872-1872).*

RITRON, INC. LIMITED WARRANTY

WHAT THIS WARRANTY COVERS

RITRON, INC. ("RITRON") provides the following warrant against defects in materials and/or workmanship in **RITRON Radios, Rechargeable Batteries and Accessories** under normal use and service during the applicable warranty period (as stated below). "Accessories" means antennas, holsters, chargers, earphones, speaker / microphones and items contained in the programming and programming / service kits. Rechargeable batteries will be replaced during the applicable warranty period only if leakage occurs or the batteries drop below 75% of rated capacity.

| <u>WHAT IS COVERED</u> | <u>FOR HOW LONG</u> | <u>WHAT RITRON WILL DO</u> |
|------------------------------------|---------------------|---|
| Portable JMX Display Series Radios | 1 year * | During the first year after date of purchase, RITRON will repair or replace the defective product, at RITRON's option, parts and labor included at no charge. |
| RITRON Rechargeable Batteries | 1 year * | RITRON will replace the defective battery |
| Accessories | 90 days * | *After date of purchase |

WHAT THIS WARRANTY DOES NOT COVER

- Any technical information provided with the covered product or any other RITRON products;
- Installation, maintenance or service of the product, unless this is covered by a separate written agreement with RITRON;
- Any products not furnished by RITRON which are attached or used with the covered product, or defects or damage from the use of the covered product with equipment that is not covered (such as defects or damage from the charging or use of batteries other than with covered product);
- Defects or damage, including broken antennas, resulting from:
 - misuse, abuse, improper maintenance, alteration, modification, neglect, accident or act of God,
 - the use of covered products other than in normal and customary manner or,
 - improper testing or installation;
- Defects or damages from unauthorized disassembly, repair or modification, or where unauthorized disassembly, repair or modification prevents inspection and testing necessary to validate warranty claims;
- Defects or damages in which the serial number has been removed, altered or defaced.
- Batteries if any of the seals are not intact.

IMPORTANT: This warrant sets forth the full extent of RITRON's express responsibilities regarding the covered products, and is given in lieu of all other express warranties. What RITRON has agreed to do above is your sole and exclusive remedy. No person is authorized to make any other warrant to you on behalf of RITRON. Warranties implied by state law, such as implied warranties of merchantability and fitness for a particular purpose, are limited to the duration of this limited warrant as it applies to the covered product. Incidental and consequential damages are not recoverable under this warranty (this includes loss of use or time, inconvenience, business interruption, commercial loss, lost profits or savings). **Some states do not allow the exclusion or limitation of incidental or consequential damages, or limitation on how long an implied warranty lasts, so the above limitations or exclusions may not apply to you. Because each covered product system is unique, RITRON disclaims liability for range, coverage, or operation of the system as a whole under this warranty.**

WHO IS COVERED BY THIS WARRANTY

This warranty is given only to the purchaser or lessee of covered products when acquired for use, not resale. This warranty is not assignable or transferable.

HOW TO GET WARRANTY SERVICE

To receive warranty service, you **MUST** deliver or send the defective product, delivery costs and insurance prepaid, within the applicable warranty period, to RITRON, INC., 505 West Carmel Drive, Carmel, Indiana 46032, Attention: Warranty Department.

Please point out the nature of the defect in as much detail as you can. **You MUST retain your sales or lease receipt (or other written evidence of the date of purchase) and deliver it along with the product.** If RITRON chooses to repair or replace a defective product, RITRON may replace the product or any part or component with reconditioned product, parts or components. Replacements are covered for the balance of the original applicable warranty period. All replaced covered products, parts or components become RITRON's property.

RIGHTS TO SOFTWARE RETAINED

Title and all rights or licenses to patents, copyrights, trademarks and trade secrets in any RITRON software contained in covered products are and shall remain in RITRON. RITRON nevertheless grants you a limited non-exclusive, transferable right to use the RITRON software only in conjunction with covered products. No other license or right to the RITRON software is granted or permitted.

YOUR RIGHTS UNDER STATE LAW

This warranty gives you specific legal rights, and you may also have other rights which vary from state to state.

WHERE THIS WARRANTY IS VALID

This warranty is valid only within the United States, the District of Columbia and Puerto Rico.



Pub. 14500046 REV. C 06-12

COPYRIGHT© 2003-2012 Ritron, Inc. · ALL RIGHTS RESERVED

RITRON, JOBCOM, QUICK ASSIST, and QUIET CALL ARE REGISTERED TRADEMARKS OF RITRON, INC.

505 West Carmel Drive • Carmel, IN 46032

P. O. Box 1998 • Carmel, IN 46032

Ph: 317-846-1201 • Fax: 317-846-4978 • Email: ritron@ritron.com

Website: www.ritron.com